

Quick Installation Guide

N600 Wireless Dual Band Gigabit VDSL2 Modem Router

Please select the appropriate setup wizard.

CD Setup Wizard

For Windows users only

Web-based Quick Setup Wizard

For users unable to run the Resource CD

MODEL NO. TD-W9980/TD-W9980B 

Package Contents

The product model shown in this QIG is TD-W9980, as an example.

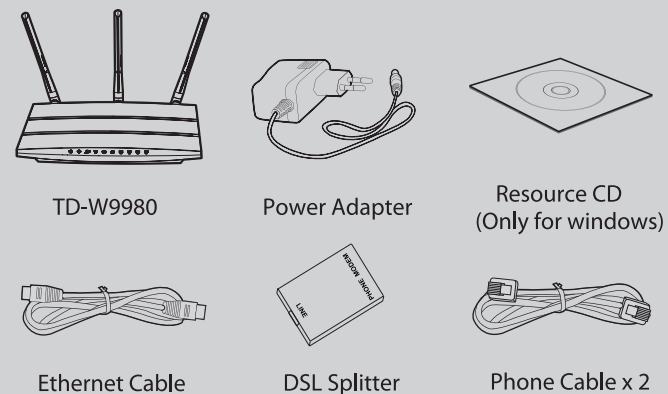

QIG

Necessary Information

For a smoother setup, we suggest you consult your ISP for the following information first. The information will be necessary during the configuration stage.

VPI/VCI: _____ Connection Type: _____

Encapsulation Mode (Optional): _____

VLAN ID (Optional): _____

CD Setup Wizard (For Windows users only)

1 Insert the TP-LINK Resource CD into the CD-ROM drive.

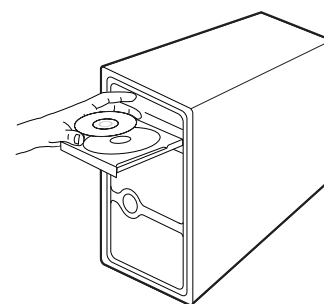

2 Click **Start Setup**.



3 Follow the pop-up flash video to connect your devices, then click to continue.

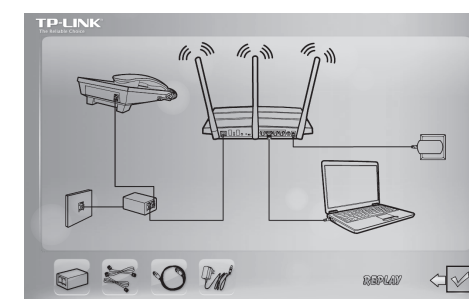

4 Please check the LEDs (especially the DSL LED). Then click **NEXT** and follow the step-by-step instructions until you complete the configuration.

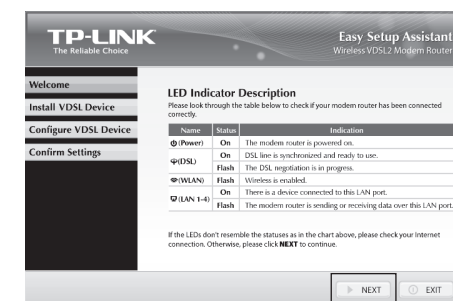

For the advanced configurations, please refer to the User Guide on the Resource CD provided.

Web-based Quick Setup Wizard (For users unable to run the Resource CD)

1 Connect your devices step by step following the figure.

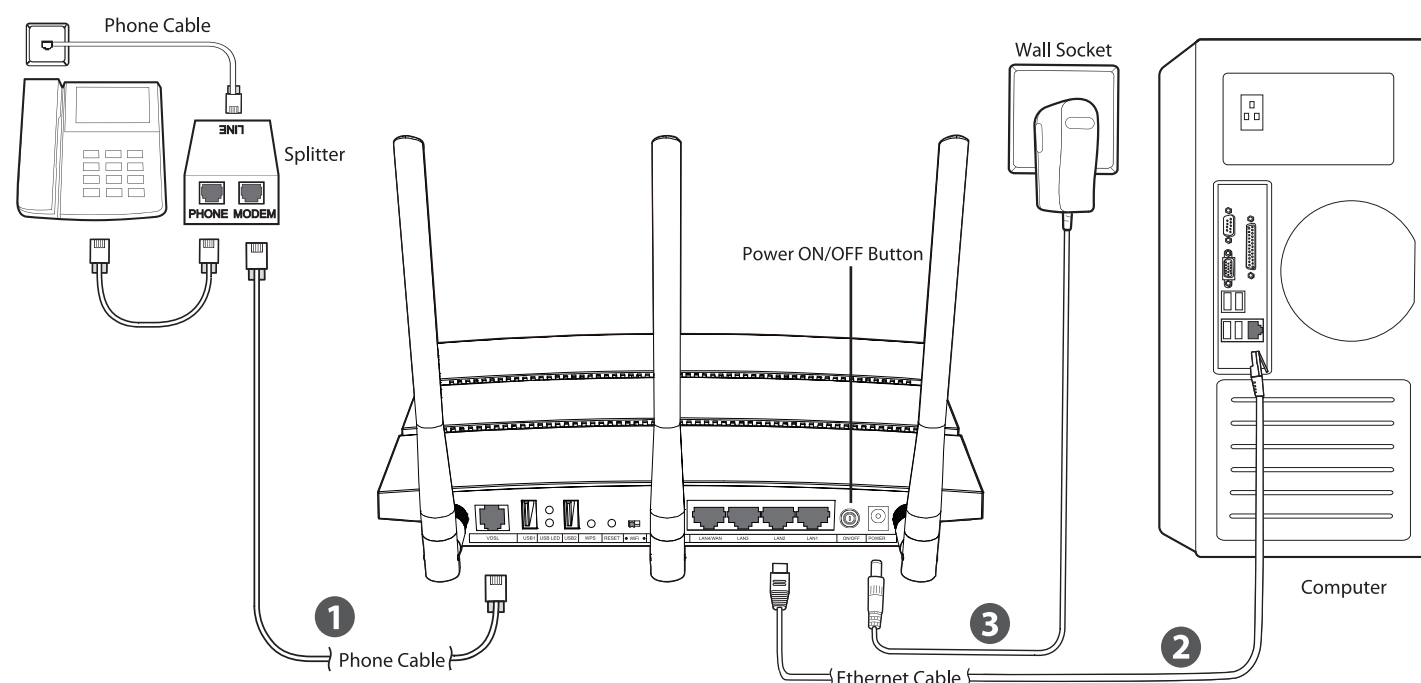

2 Press the **ON/OFF** button of your modem router and make sure the LEDs (especially the DSL LED) display as shown below.

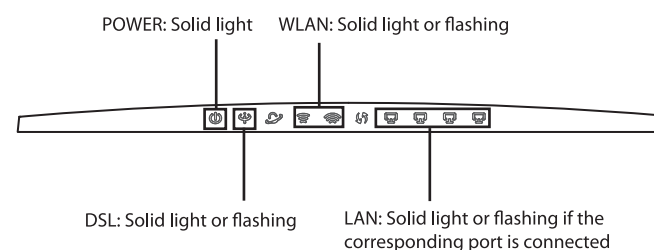

3 Set your computer to **Obtain an IP address/DNS server address automatically**. For details, please refer to **T1 in Troubleshooting**.

4 Open your browser and type in **http://tplinkmodem.net** in the address field, then press Enter. Use the default username **admin** and password **admin** to log into the Web-management page.

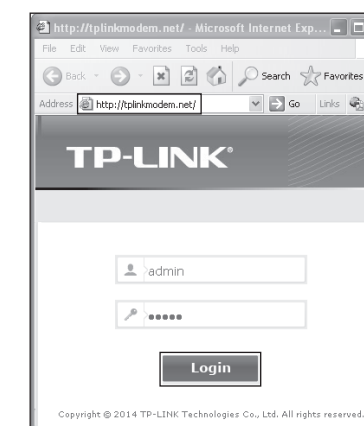

5 Click **Quick Setup** in the main menu and then click **Next** to start the configuration.

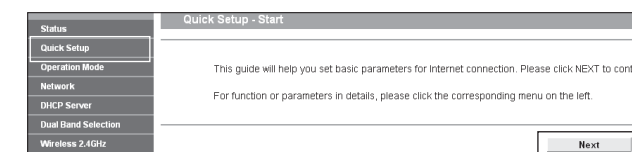

Web-based Quick Setup Wizard (For users unable to run the Resource CD)

- 6** Select your **Region** and **Time Zone** from the drop-down list, then click **Next**.

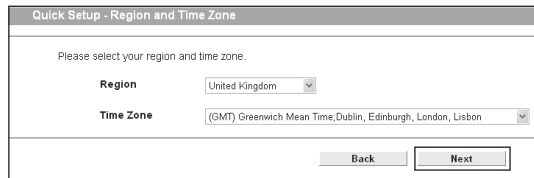

- 7** Choose your desired mode and then click **Next**. Here we use **xDSL Modem Router Mode** as an example.

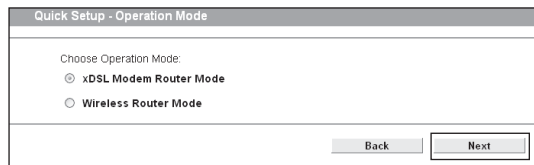

- 8** Select your **ISP** from the drop-down list, then click **Next**.

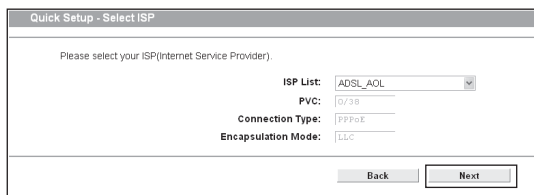

Note If your ISP is not listed, please select **others** and click **Next**. On the following page select the **L2 Interface Type**, enter the values given by your ISP, then click **Next**.

- 9** Here we use **PPPoE** as an example. Enter the PPPoE Username and Password provided by your ISP, then click **Next**.

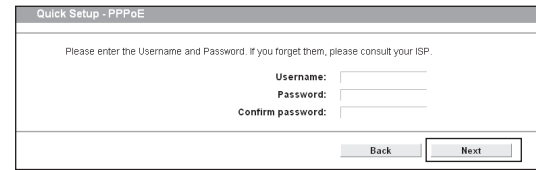

Record this information here:
Username: _____
Password: _____

- 10** You can rename your 2.4GHz wireless network and create your own password in this page. The default wireless name is TP-LINK_2.4GHz_XXXXXX; and the default wireless password, the same as the PIN code, is printed on the bottom label. Click **Next** to continue.

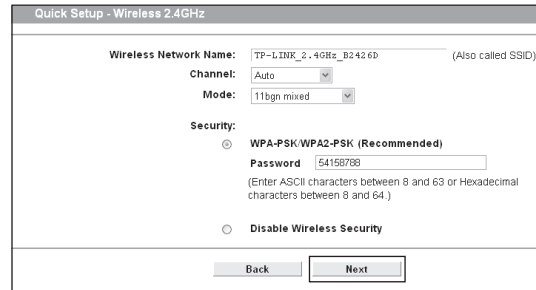

- 11** You can rename your 5GHz wireless network and create your own password in this page. The default wireless name is TP-LINK_5GHz_XXXXXX; and the default wireless password, the same as the PIN code, is printed on the bottom label. Click **Next** to continue.

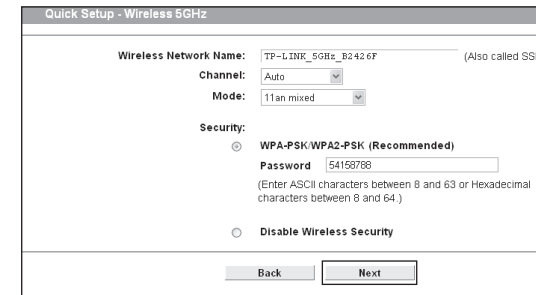

Record your wireless information here:
2.4GHz SSID: _____
2.4GHz Security Password: _____
5GHz SSID: _____
5GHz Security Password: _____

- 12** Please confirm all the parameters. Click **Back** to modify them or click **Save** to save your settings.

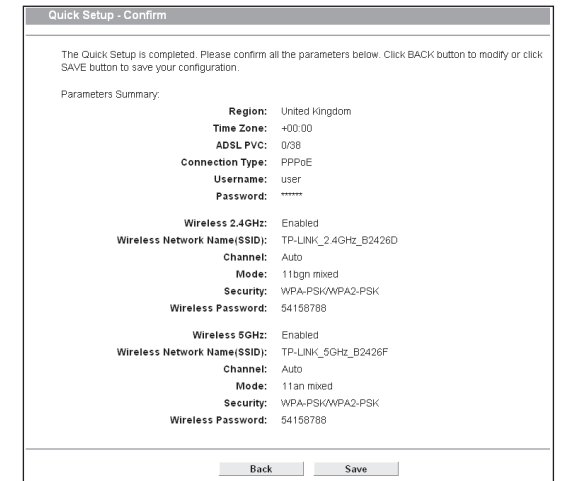

- 13** Quick Setup has completed. Click **Finish** to make your settings take effect.

The basic settings for your modem router are completed. Please open the web browser and try to log on to <http://www.tp-link.com> to test your Internet connection.

Note For the advanced configurations, please refer to the User Guide at <http://www.tp-link.com>.

Troubleshooting

T1. How can I set my computer to Obtain an IP address / DNS server address automatically?

For Mac OS X

- 1) Click the **Apple** icon on the upper left corner of the screen.
- 2) Go to **"System Preferences -> Network"**.
- 3) Select **Airport** on the left menu bar, and then click **Advanced** for wireless configuration; or select **Ethernet** for wired configuration.
- 4) In the **Configure IPv4** box under **TCP/IP**, select **Using DHCP**.
- 5) Click **Apply** to save the settings.

For Windows 7

- 1) Click **"Start -> Control Panel -> Network and Internet -> View network status -> Change adapter settings"**.
- 2) Right-click **Wireless Network Connection** (or Local Area Connection), and then click **Properties**.
- 3) Select **Internet Protocol Version 4 (TCP/IPv4)**, and then click **Properties**.
- 4) Select **Obtain an IP address automatically and Obtain DNS server address automatically**. Then click **OK**.

For Windows XP

- 1) Click **"Start -> Control Panel -> Network and Internet Connections -> Network Connections"**.
- 2) Right-click **Wireless Network Connection** (or Local Area Connection), and then click **Properties**.
- 3) Select **Internet Protocol (TCP/IP)**, and then click **Properties**.
- 4) Select **Obtain an IP address automatically and Obtain DNS server address automatically**. Then click **OK**.

For Windows 8

- 1) Move your mouse to the lower right corner and click the **Search** icon in the Poppers.

- 2) Go to **Apps**, type **Control Panel** in the search box and press **Enter**.
- 3) Go to **"Control Panel -> View network status and tasks > Change adapter settings"**.
- 4) Right-click **Ethernet**, select **Properties**. Then double-click **Internet Protocol Version 4 (TCP/IPv4)**.
- 5) Select **Obtain an IP address automatically and Obtain DNS server address automatically**. Then click **OK**.

T2. What can I do if I cannot access the Internet?

- 1) Check your cables and make sure they are all plugged in correctly, including the telephone line, Ethernet cables and power adapter.
- 2) Check to see if you can log on to the Web-Management page of the modem router. The default address of the Web-Management page is <http://tplinkmodem.net>. If you can, try the following steps. (If you can not, please refer to **T1** to configure TCP/IP Properties and then try to access the Internet again.)
- 3) Consult your ISP and make sure all the VPI/VCI, Connection Type, account username and password are correct. If they are not, please replace them with the correct settings and try again.
- 4) If you still cannot access the Internet, please restore your modem router to its factory default settings and reconfigure your modem router following the instructions in this QIG.
- 5) Please contact our Technical Support if the problem still exists.

T3. How can I restore my modem router's configuration to its factory default settings?

Once the modem router is reset, the current settings will be lost and you will need to reconfigure the modem router. We strongly suggest you back up

the current settings before resetting the modem router. For more Backup information, please refer to 4.2.2.6 Backup & Restore on User Guide.

With the modem router powered on, use a pin to press and hold the **RESET** button on the rear panel for 8 to 10 seconds before releasing it.

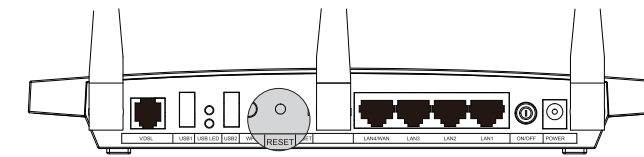

T4. What can I do if I forget my password?

- 1) For default wireless password: Please refer to the "Wireless Password/PIN" labeled on the bottom of the modem router.
- 2) For the web management page password: Reset the modem router first and then use the default user name and password: **admin/admin**.

T5. How can I configure the USB features?

Please refer to our Application Guides. They can be found on the resource CD, or on the web.

- 1) CD Access: Open the "Application Guide" folder on the Resource CD. The guides can be found inside this folder.
- 2) Web Access: <http://www.tp-link.com/app/usb>

Note For more details about Troubleshooting and Technical Support contact information, please log on to our Technical Support website: <http://www.tp-link.com/en/support>



Technical Support

- For more troubleshooting help, go to <http://www.tp-link.com/en/support/faq>
- To download the latest Firmware, Driver, Utility and User Guide, go to <http://www.tp-link.com/en/support/download>

- For all other technical support, please contact us by using the following details:

Global Tel: +86 755 2650 4400 Fee: Depending on rate of different carriers, IDD. E-mail: support@tp-link.com Service time: 24hrs, 7 days a week	Australia / New Zealand Tel: NZ 0800 87 5465 (Toll Free) AU 1300 87 5465 (Depending on 1300 policy.) E-mail: support.au@tp-link.com (Australia) support.nz@tp-link.com (New Zealand) Service time: 24hrs, 7 days a week
USA / Canada Toll Free: +1 866 225 8139 E-mail: support.usa@tp-link.com (USA) support.ca@tp-link.com (Canada) Service time: 24hrs, 7 days a week	Singapore Tel: +65 6284 0493 Fee: Depending on rate of different carriers. E-mail: support.sg@tp-link.com Service time: 24hrs, 7 days a week
UK Tel: +44 (0) 845 147 0017 Fee: Landline: 1p-10.5p/min, depending on the time of day. Mobile: 15p-40p/min, depending on your mobile network. E-mail: support.uk@tp-link.com Service time: 24hrs, 7 days a week	Ukraine Toll Free: 0800 505 508 Fee: Free for Landline; Mobile: Depending on rate of different carriers. E-mail: support.ua@tp-link.com Service time: Monday to Friday, 10:00 to 22:00
Turkey Toll Free: 0850 7244 488 (Turkish Service) Fee: Depending on rate of different carriers. E-mail: support.tr@tp-link.com Service time: 09:00 to 21:00, 7 days a week	Malaysia Toll Free: 1300 88 875 465 E-mail: support.my@tp-link.com Service time: 24hrs, 7 days a week
Brazil Toll Free: 0800 608 9799 (Portuguese Service) E-mail: support.br@tp-link.com Service time: Monday to Friday, 09:00 to 20:00; Saturday, 09:00 to 15:00	Poland Tel: +48 (0) 801 080 618 +48 223 606 363 (if calls from mobile phone) Fee: Depending on rate of different carriers. E-mail: support.pl@tp-link.com Service time: Monday to Friday, 09:00 to 17:00. GMT+1 or GMT+2 (DST)
Italy Tel: +39 023 051 9020 Fee: Depending on rate of different carriers. E-mail: support.it@tp-link.com Service time: Monday to Friday, 09:00 to 13:00; 14:00 to 18:00	Switzerland Tel: +41 (0)848 800 998 (German Service) Fee: 4-8 Rp/min, depending on rate of different time. E-mail: support.ch@tp-link.com Service time: Monday to Friday, 09:00 to 12:30 and 13:30 to 18:00. GMT+1 or GMT+2 (DST)
Indonesia Tel: (+62) 021 6386 1936 Fee: Depending on rate of different carriers. E-mail: support.id@tp-link.com Service time: Sunday to Friday, 09:00 to 12:00; 13:00 to 18:00 *Except public holidays	France Tel: 0820 800 860 (French service) Fee: 0.118 EUR/min from France Email: support.fr@tp-link.com Service time: Monday to Friday, 09:00 to 18:00 *Except French Bank holidays
Germany / Austria Tel: +49 1805 875 465 (German Service) +49 1805 TPLINK +43 820 820 360 Fee: Landline from Germany: 0.14EUR/min. Landline from Austria: 0.20EUR/min. E-mail: support.de@tp-link.com Service Time: Monday to Friday, 09:00 to 12:30 and 13:30 to 18:00. GMT+1 or GMT+2 (DST in Germany)	Russian Federation Tel: 8 (499) 754 5560 (Moscow NO.) 8 (800) 250 5560 (Toll-free within RF) E-mail: support.ru@tp-link.com Service time: From 09:00 to 21:00 (Moscow time) *Except weekends and holidays in RF